

Features

- Stopping plug for unused cable entries
- Brass nickel-plated
- Thread M25
- Hexagon head
- Ex db, Ex eb and Ex tb certified
- Seal chloroprene
- Suitable for operation in Zone 1, Zone 2, Zone 21 and Zone 22
- Suitable for operation in Class I, Zone 1/2/22
- Suitable for operation in Class I, Division 2 when installed in accordance with NEC501.10(B)(2)
- Degree of protection IP66 / IP68, UL Type 4X
- Packaging unit: 1 piece, kit with accessories

Assembly**Technical data****Mechanical specifications**

Thread type	metric ISO pitch 1.5 mm
Thread size (TD)	M25
Degree of protection	IP66 / IP68 , UL Type 4X

Material	
Finish	inherent color silver
Washer gasket	aramid fibers bonded with NBR
O-Ring	chloroprene
Stopping plug	brass, nickel-plated

Mass	
Individual component	approx. 49 g
Packing unit	approx. 68 g

Dimensions	
Diameter thru-hole (DT)	25 ... 25.2 mm
Width across flats (SW1)	30 mm
Thread length (TL)	15.5 mm
Total length (L)	21 mm

Tightening torque	
Nut torque at enclosure (SW1)	8.5 Nm

Ambient conditions

Ambient temperature	-40 ... 100 °C (-40 ... 212 °F) washer gasket: -40 ... 80 °C (-40 ... 176 °F)
---------------------	--

Data for application in connection with hazardous areas

EU-type examination certificate	CESI 15 ATEX 029 X
---------------------------------	--------------------

Marking	Ex II 2 GD Ex db IIC Gb Ex eb IIC Gb Ex tb IIIC Db
International approvals	
UL approval	
cULus	E305142 tested to UL 50E and UL 508A
CSA approval	CSA C22.2, No. 14-13
IECEX approval	IECEX CES 15.0006X
EAC approval	TC RU C-TR.GB05.B.00918
Conformity	
Degree of protection	EN 60529
General information	
Delivery quantity	1
Scope of delivery	Stopping Plugs, Metal washer gasket locknut brief instructions
Supplementary information	EC-Type Examination Certificate, Statement of Conformity, Declaration of Conformity, Attestation of Conformity and instructions have to be observed where applicable. For information see www.pepperl-fuchs.com .

Dimensions

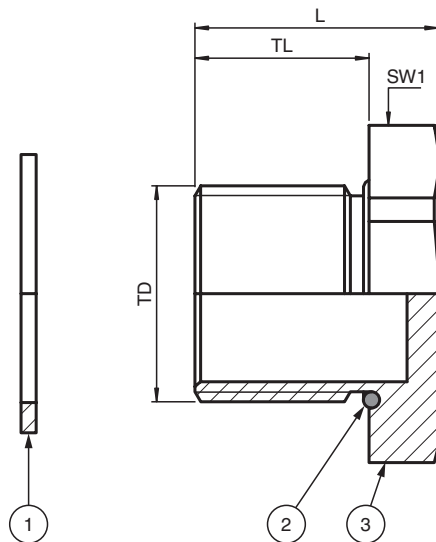

Legend

1	Washer gasket (accessory, metric versions only)
2	O-Ring (metric versions only)
3	Stopping plug
L	Total length
SW*	Width across flats
TD	Thread size
TL	Thread length

Release date 2019-08-05 16:39 Date of issue 2019-08-05 291468_eng.xml